

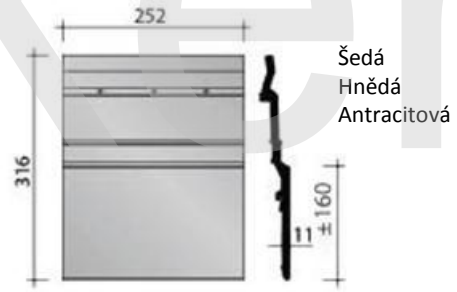

Fasádní keramický závěsný systém

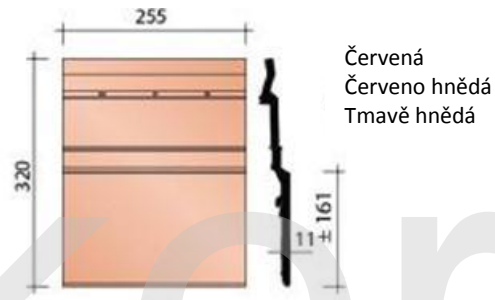

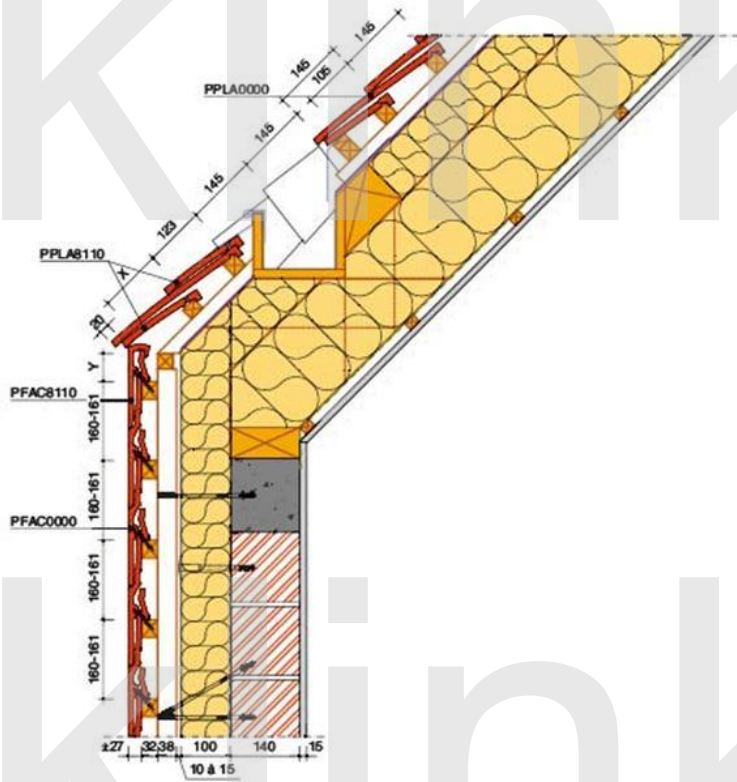

Koncová keramická tvarovka

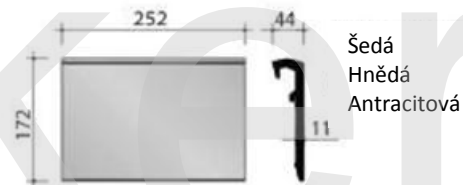
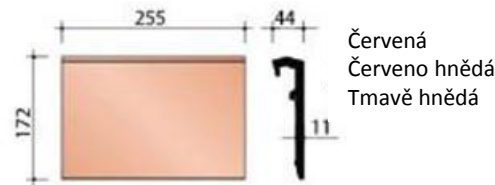



- tloušťka opláštění z keramických tvarovek 27 mm
- 24,5 ks/m²
- rozteč latí = 160 – 161 mm v závislosti na barvě
vždy se musí změřit na stavbě a zjištěná rozteč musí být precizně dodržována.
- rozměr latí 32 x 36 mm, ošetřené a ohoblované dřevo
- Váha: 46,55 kg/m²
- Certifikát: 

klinker.cz

Barvy

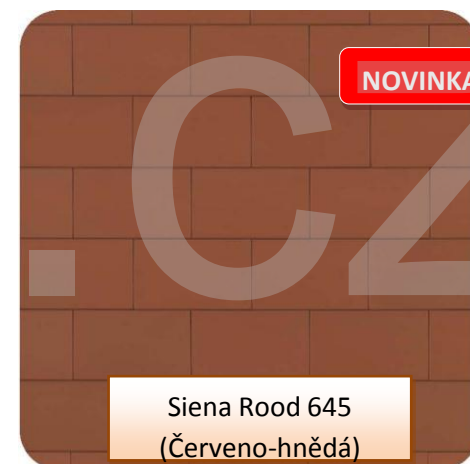

Výhody

šetrné vůči životnímu prostředí

plochý moderní vzhled

odolné vůči UV záření

bez dilatací

ideální při dodatečném
zateplení

Odolné vůči silnému větru díky
fasádnímu klipu

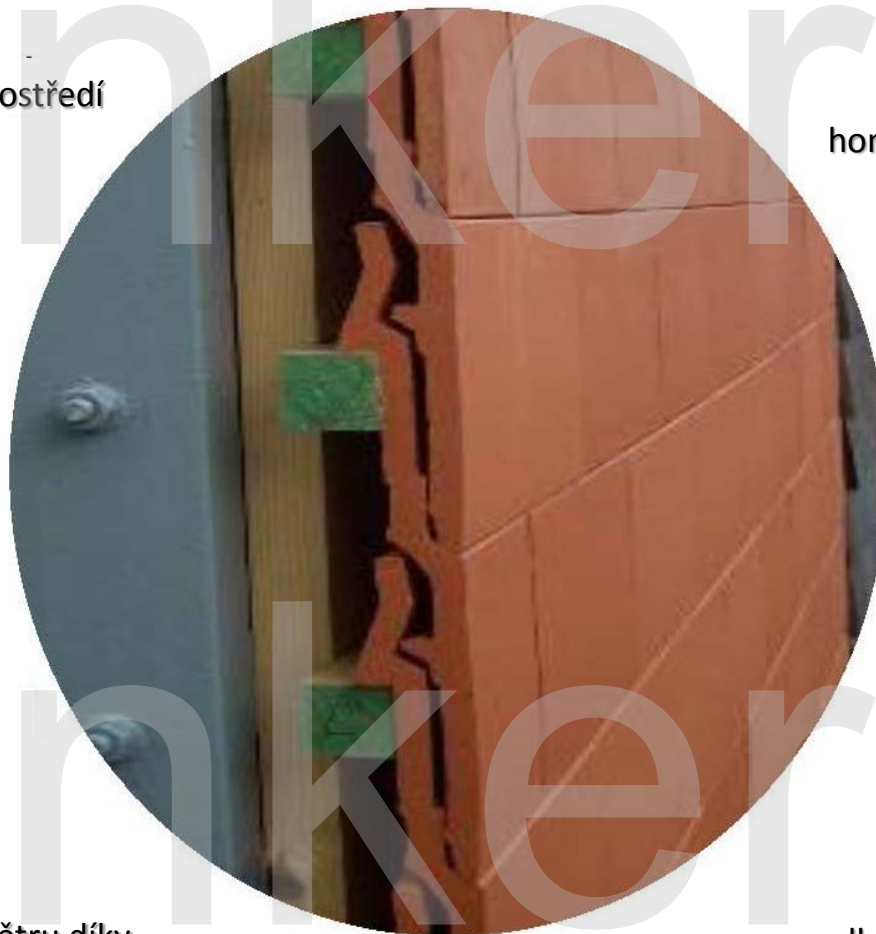

homogenita mezi střechou a fasádou

dřevěná odvětrávaná konstrukce

vodotěsné

prodyšné

bezúdržbové

suchá montáž

dlouhá životnost

Snadná instalace



Příslušenství

Fasádní rohové profily umožňují těsné zakončení budovy.



Fasádní klip: nerezový fasádní klip zabezpečuje trojitou fixaci v jednom místě



Hliníkový větrací profil: větrací profil zabraňuje vnikání hmyzu a živočichů za fasádu.
Barva: černá
Délka: 2,5 m/kus

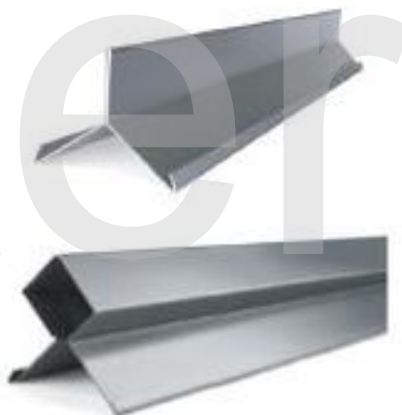

Y hliníkový rohový profil:

Barva: antracitová a hliník
Délka: 3 m/ kus

Dutý hliníkový rohový profil:

Barva: antracitová a červená
Délka: 3 m/ kus



Hliníková spojka dutých profilů:

Slouží ke spojení jednotlivých kusů dutých hliníkových rohových profilů

Detail – fasádní klip

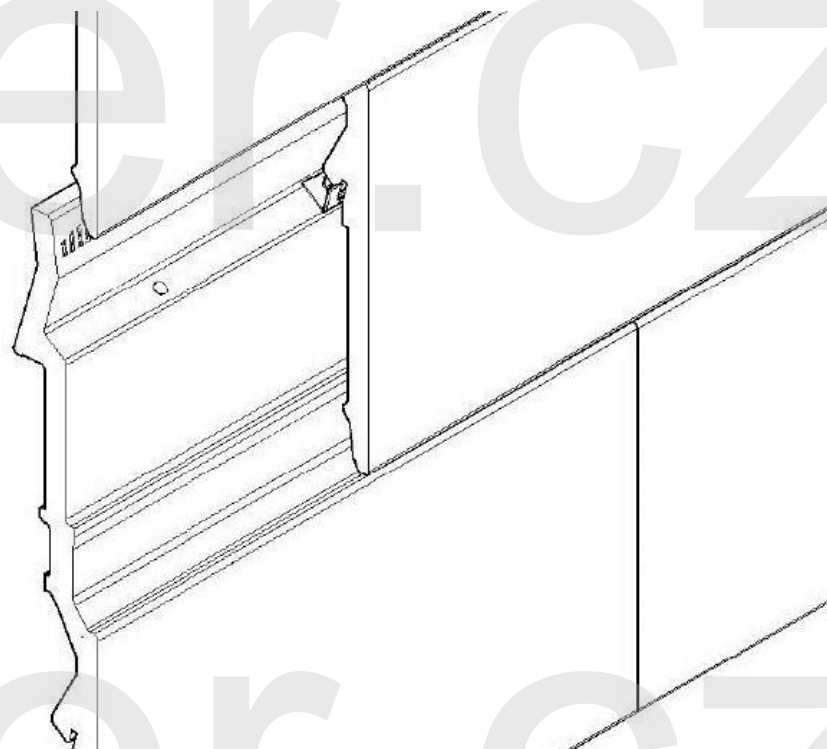

Detail – zakončení vnějšího rohu pomocí dutého rohového profilu



Keramická tvarovka

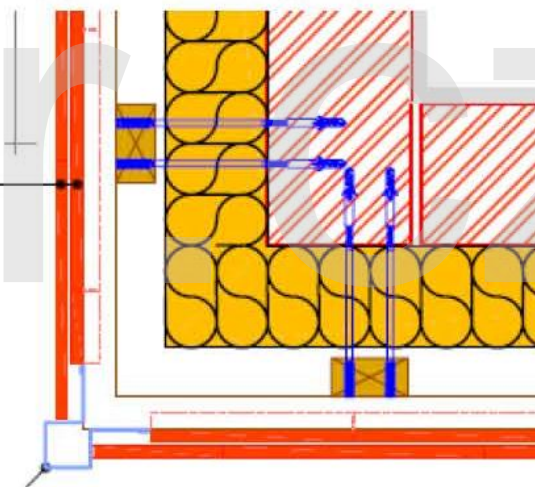

Hliníkový rohový profil

- K dostání v antracitové a červené barvě
- Délka: 3 m

Detail – zakončení vnějšího rohu pomocí Y rohového profilu

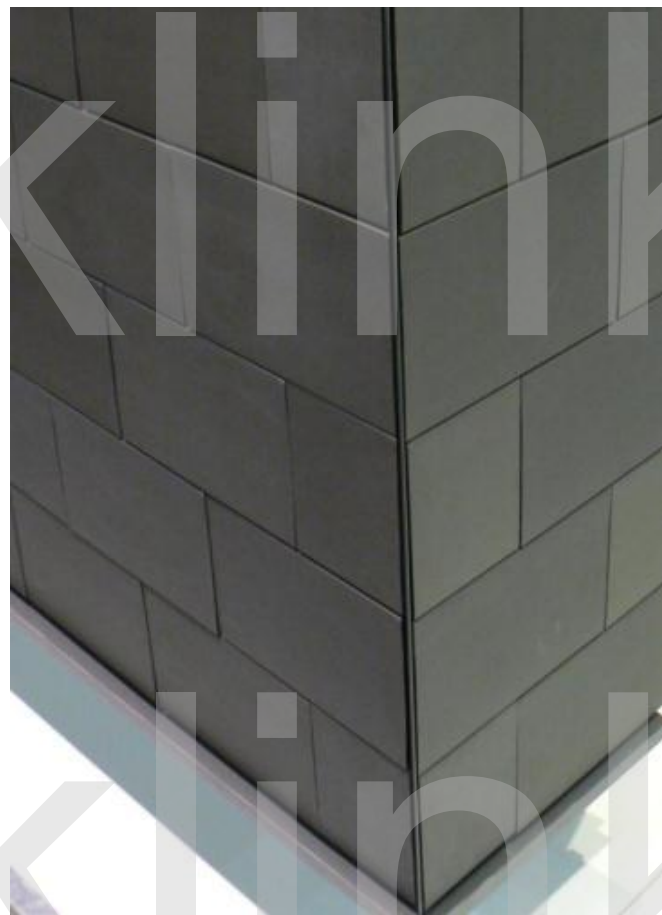

Keramická tvarovka

Rohový profil

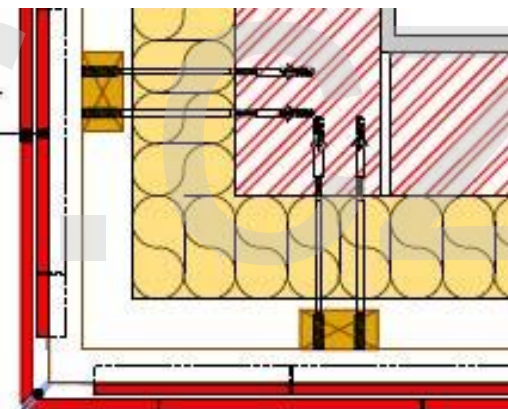

- K dostání v antracitové a hliníkové barvě
- Délka: 3 m

Detail – zakončení vnitřního rohu

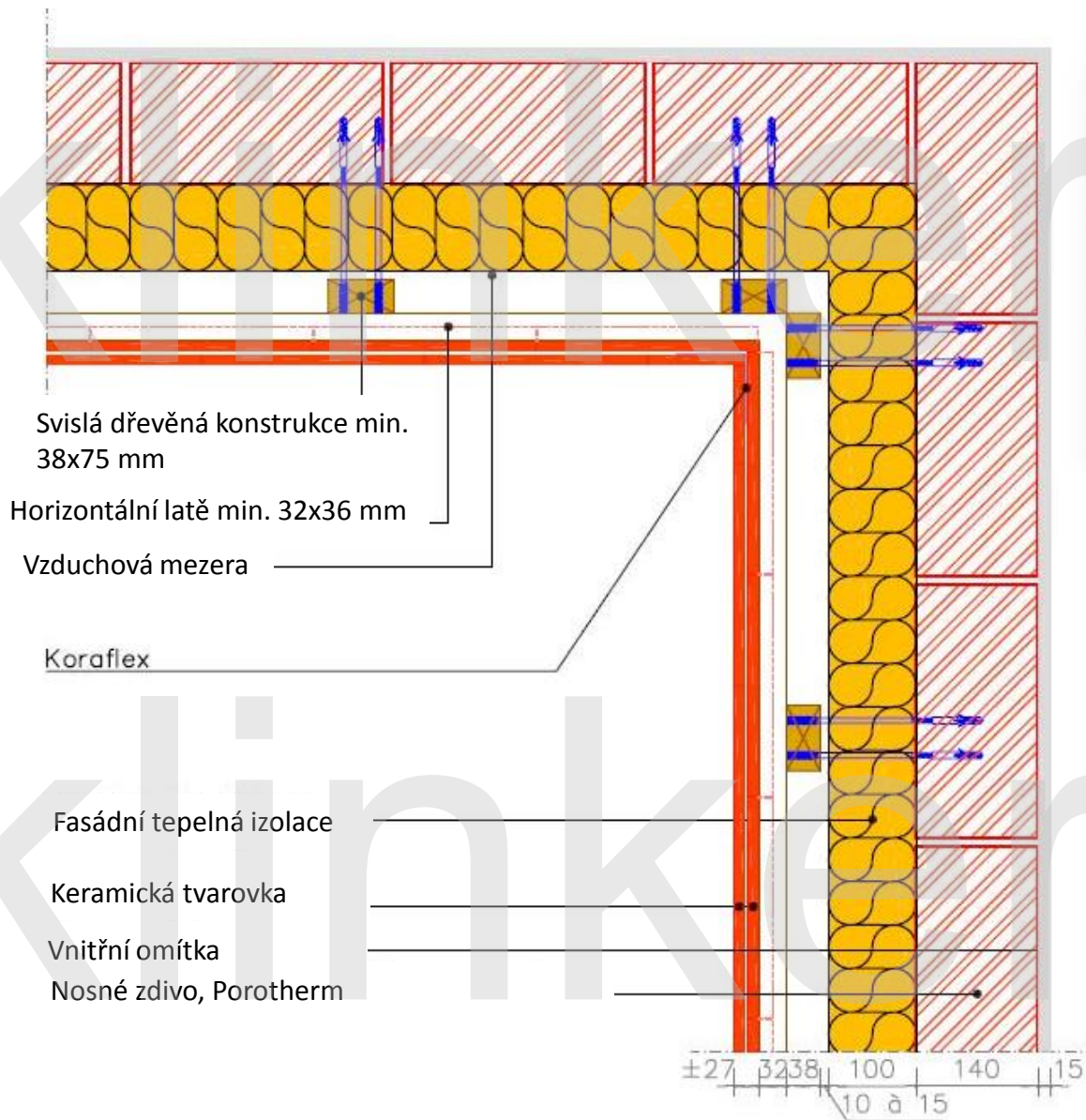

Detail – zakončení okolo oken

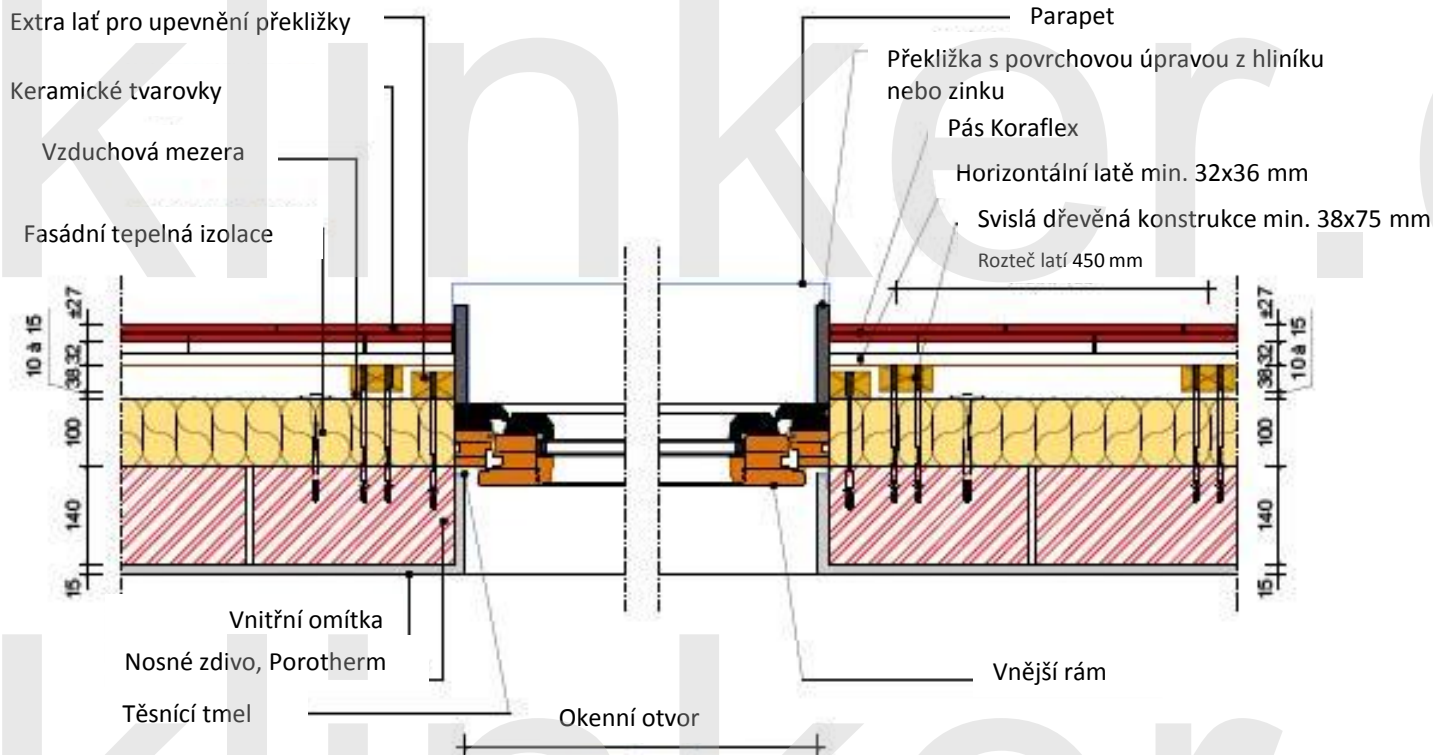

Detail – zakončení nad okny

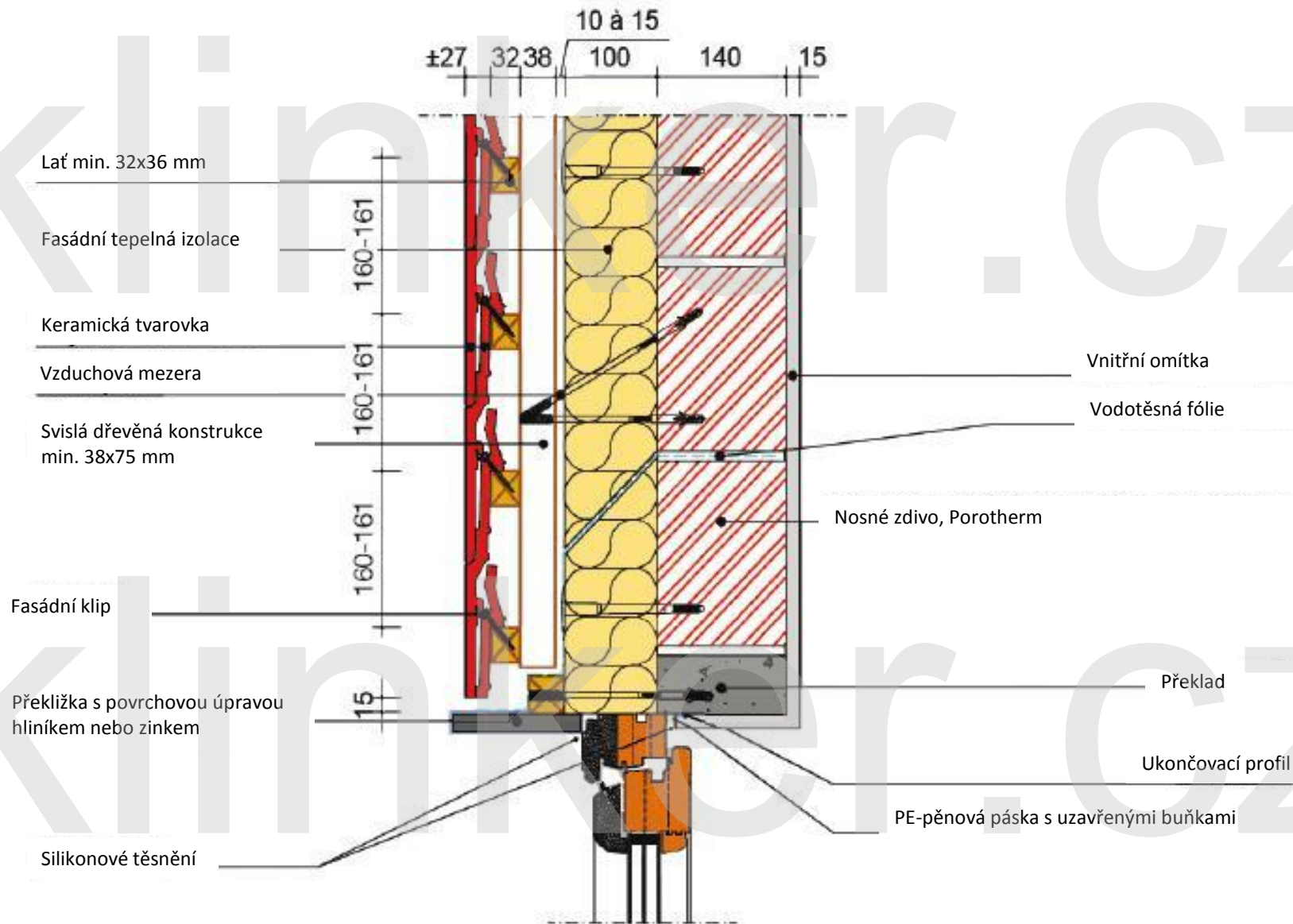

Detail – zakončení pod parapetem

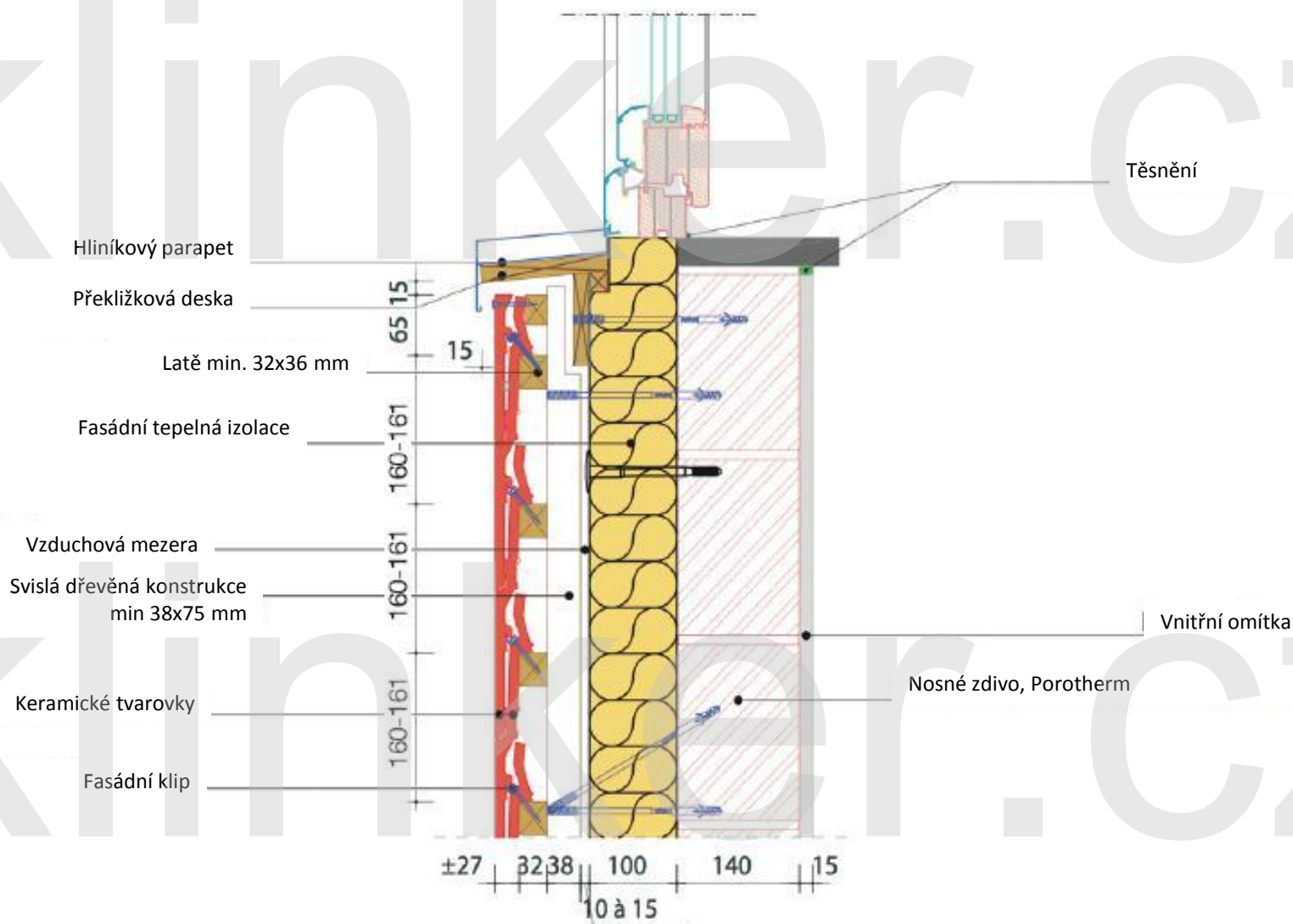

Detail – zakončení u okraje střechy

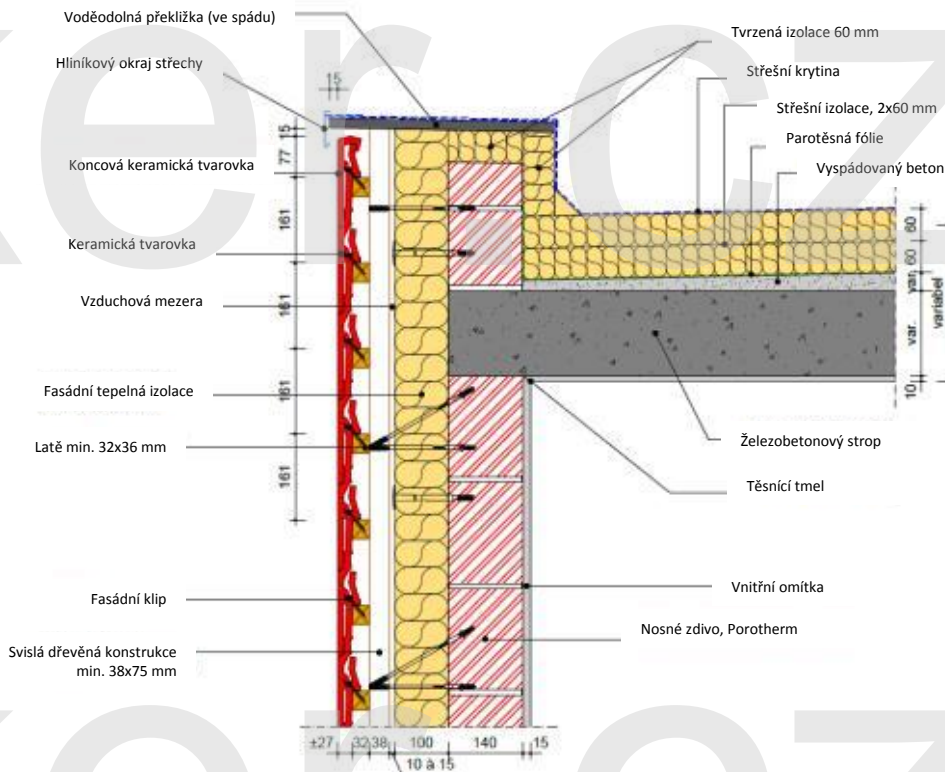
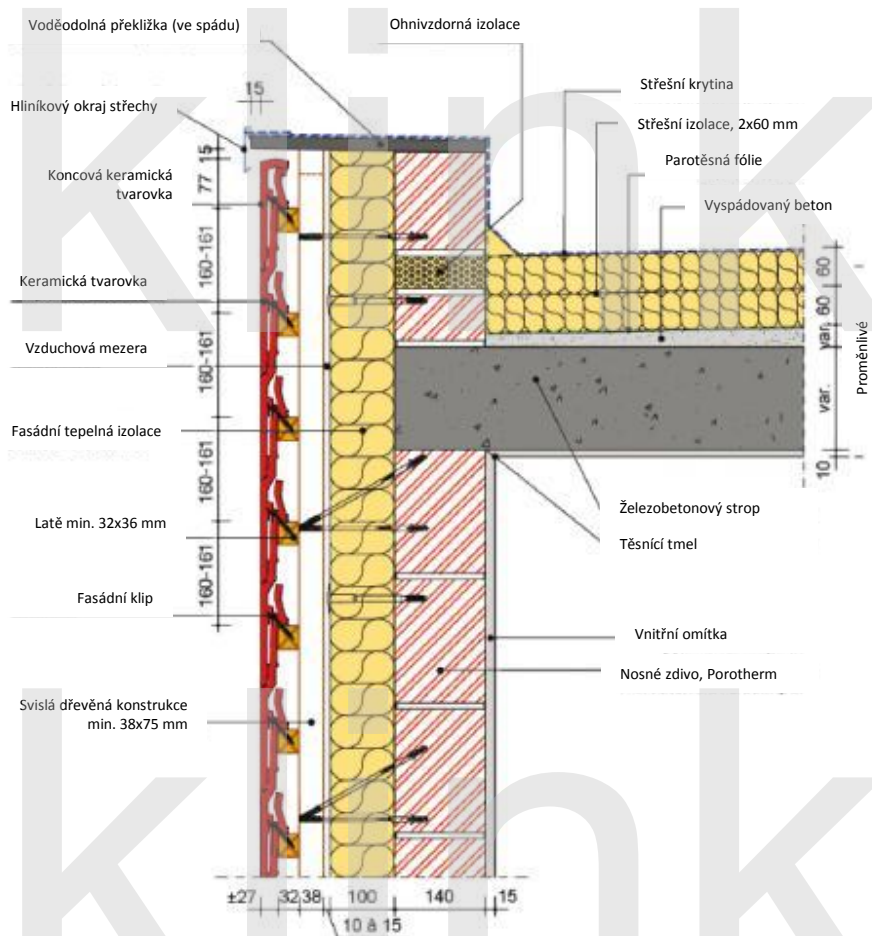

Detail – zakončení u okraje střechy



klínker.cz

Detail – zakončení ve štítu střechy

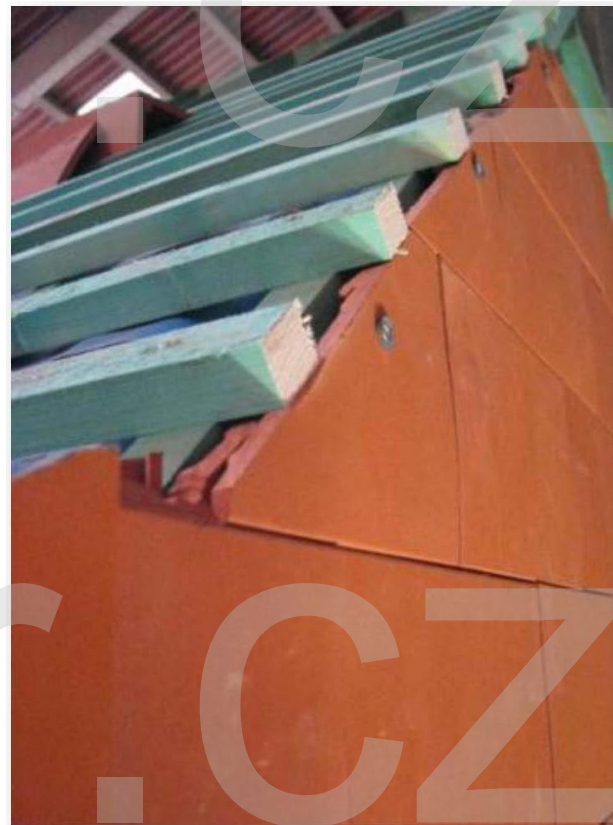
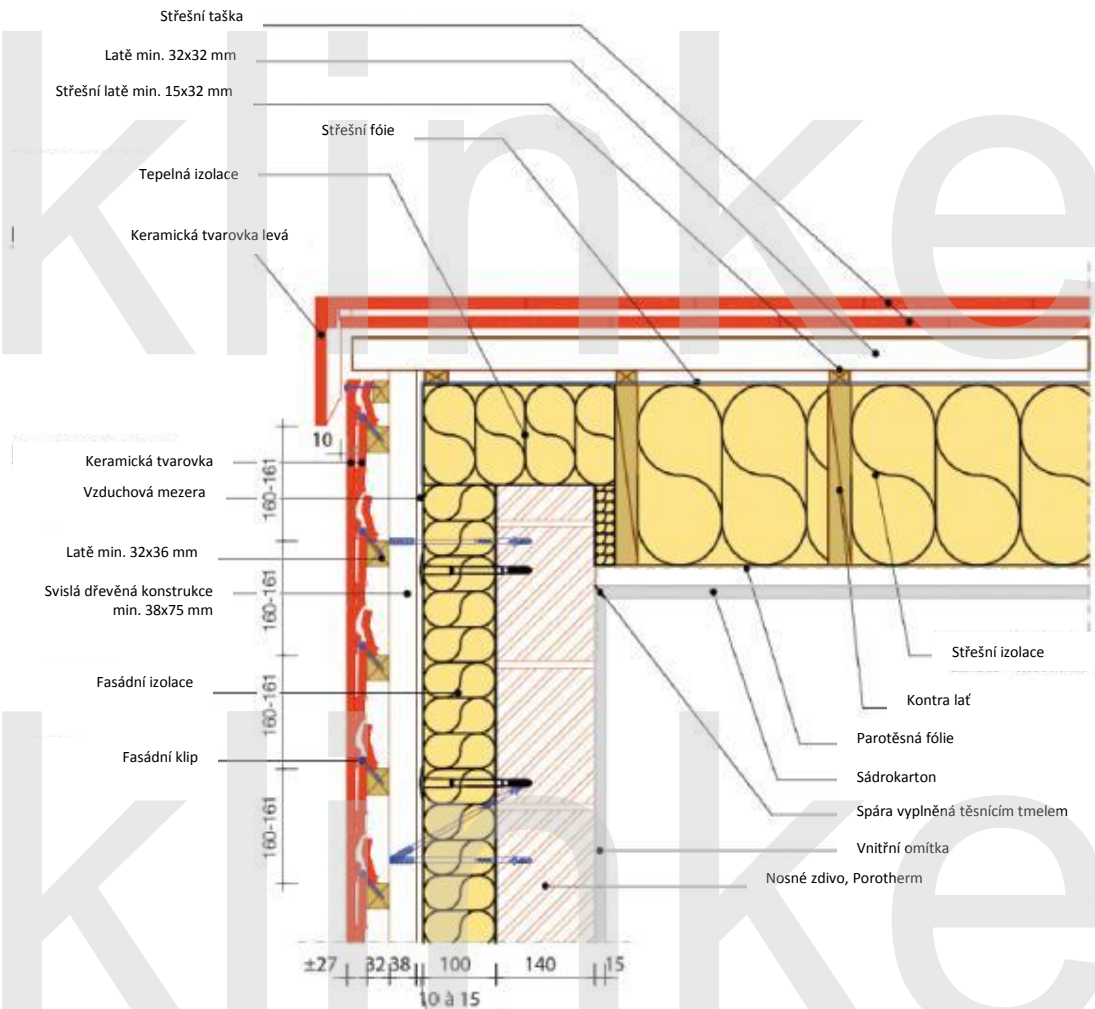

Detail – přechod fasády do šikmé střechy (skrytý okap)

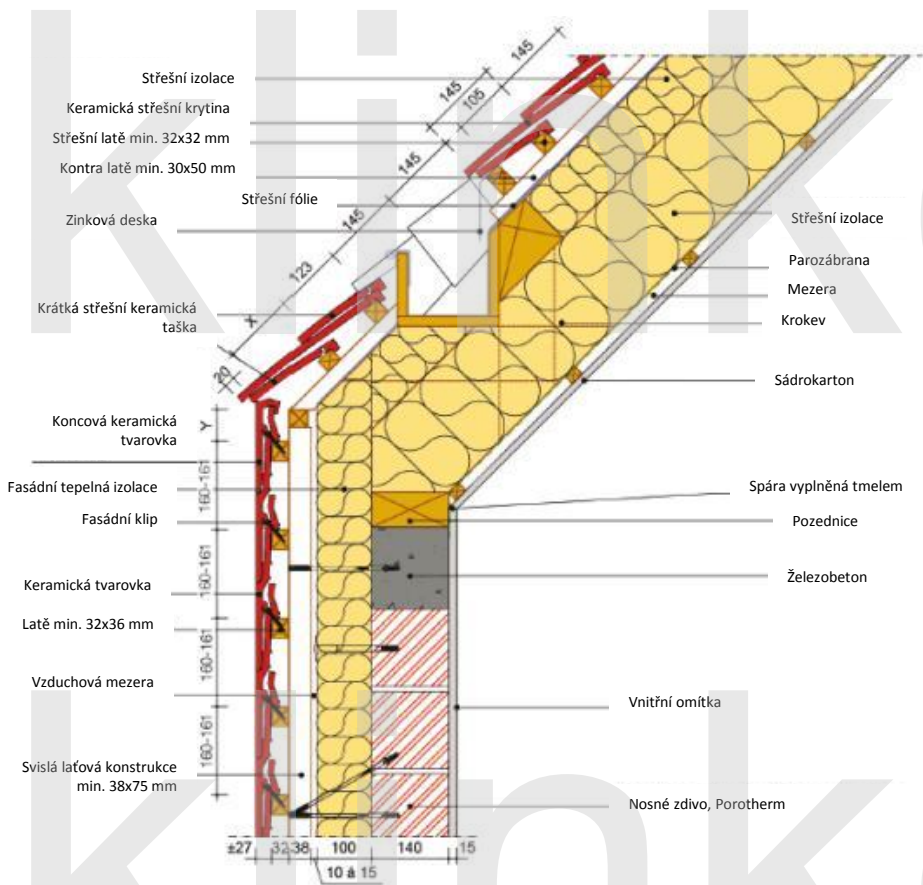

Ukázky realizací



klin

er.cz

er.cz



klinker.cz



klinker.cz





Bron: A2D architecten





X-ACT architecten



Groep3 architecten





klínk

er.cz